

STEEL POST COVERED BY RESIN

The EXCLUSIVE technology of Fumagalli posts grants to the structure the same strength features of a steel post, with all the ADVANTAGES that a maintenance-free resin material can offer.

L'ESCLUSIVA tecnologia dei pali Fumagalli assicura alla struttura le massime caratteristiche di solidità di un palo in ferro, con tutti i VANTAGGI che un materiale plastico può offrire.



STEEL STRUCTURE.

Hot dip galvanized inside and outside by zinc bath immersion.

EXPANSE.

Rigid polyurethane provides lightweight and durable filling between post and resin outer

OUTER RESIN.

Pole of a single piece, made of shockproof polymer. Moulded colours in paste, UV-rays stabilized, self extinguishing on fire, no chemical agents corrosion.

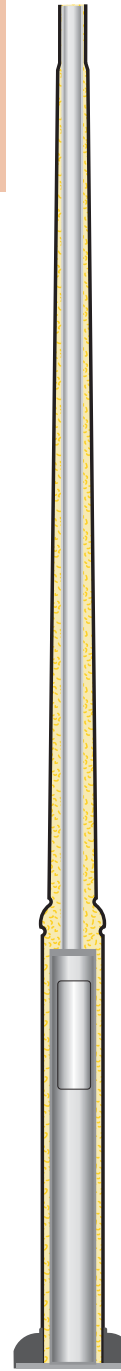

ANTI CORROSION



UV-RAYS STABILIZED



NO MAINTENANCE



DOUBLE INSULATION

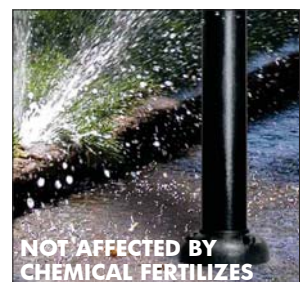

NOT AFFECTED BY CHEMICAL FERTILIZES

MODULAR SYSTEM

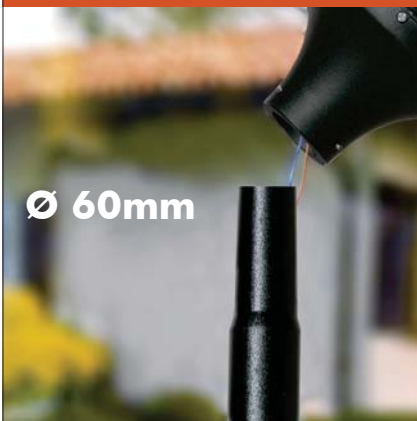

Ø 60mm

The unique 60mm hub designed into all Fumagalli luminaries and poles allows yet more flexibility in design and assembly of a host of thousands lighting solutions.

POST COLOURS



GREY

BLACK

WHITE

MODERN POST - FOUNDATION SYSTEM



SUGGESTED SIZES FOR CONCRETE FOUNDATIONS

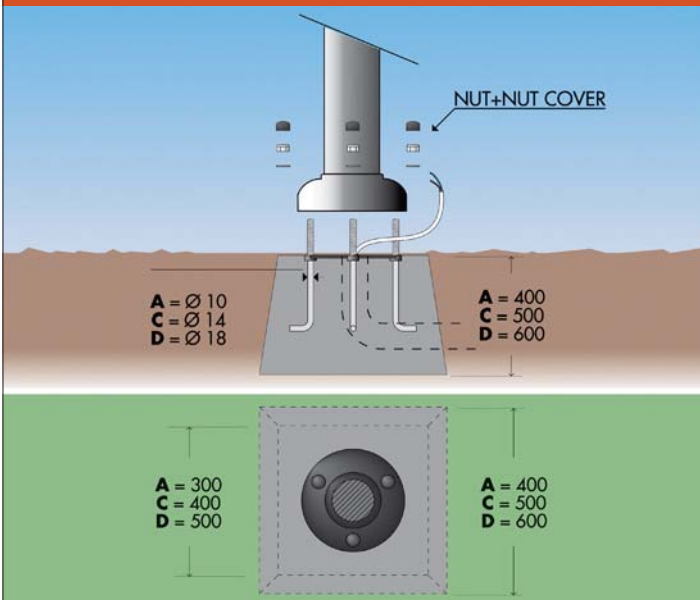

All Fumagalli poles are supplied with suitable cages for fixing into concrete foundations. The size of the cages and the size of the concrete foundation varies according to the high of the post.

Tutti i pali Fumagalli sono forniti complete di gabbie per il fissaggio a terra. Le dimensioni della gabbia e del plinto di cemento variano a secondo dell'altezza del palo.

The fixation system with two triangles allows the anchor bolts to be cemented perpendicularly to the ground. The second triangle has to be removed before installing the pole.

Il sistema di fissaggio con due triangoli assicura che i tiranti vengano affogati nel cemento in maniera perfettamente perpendicolare rispetto al terreno. Il secondo triangolo deve essere rimosso prima di procedere al fissaggio del palo.

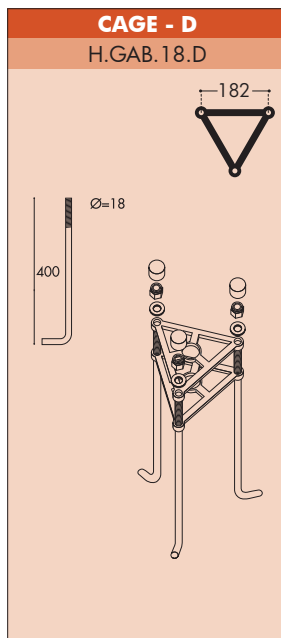
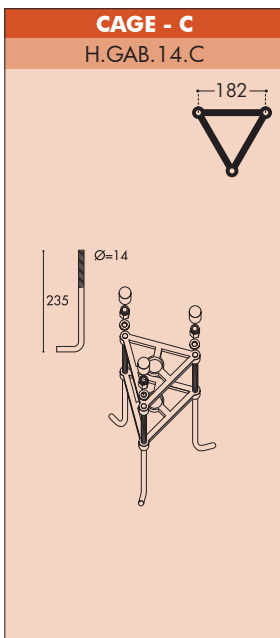
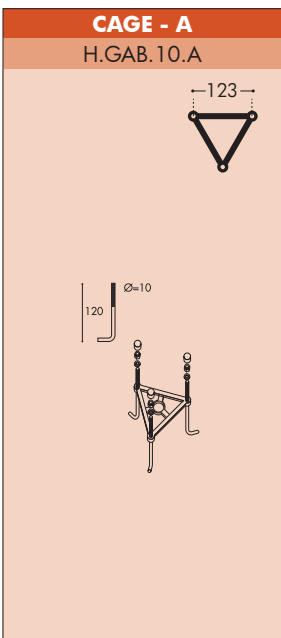

MODERN POSTS

MODERN POST COLLECTION



Each post is supplied with the suitable cage or screws for fixation.

Moulded Colours available for the MODERN range are the following:

For ARGO, FEBO and ENEA posts: **Black - White**

For EKTOR, AKILLE posts: **Black - White - Grey**

WITHOUT DOOR	000.361	000.364
WITH DOOR	000.362	000.365
WITH DOOR AND BOX	000.363	000.366

EKTOR 2500	EKTOR 3000
DOOR IS OPTIONAL	

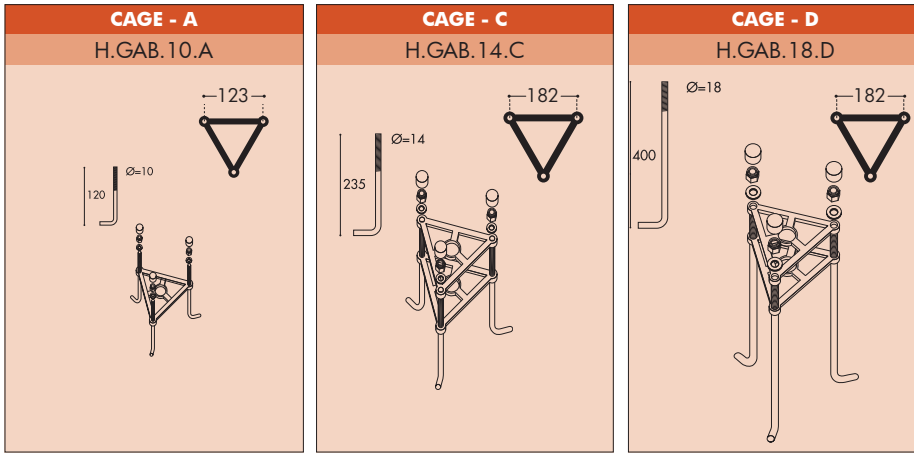

ARGO	FEBO 500	FEBO 1000	FEBO 1500	ENEA 2000	ENEA 2400	ENEA 2800
000.241	000.261	000.262	000.263	000.264	000.265	000.266
resin	resin	resin		DOOR NOT AVAILABLE		
DOOR NOT AVAILABLE						
Pcs 10 Kg 5,0 mc 0,060	Pcs 4 Kg 6,7 mc 0,057	Pcs 4 Kg 9,3 mc 0,086	Pcs 4 Kg 19,6 mc 0,118	Pcs 2 Kg 17,3 mc 0,111	Pcs 2 Kg 21,2 mc 0,132	Pcs 2 Kg 25,3 mc 0,151
SCREWS	CAGE - A	CAGE - A	CAGE - A	CAGE - A	CAGE - A	CAGE - A

Pcs 1 Kg 30 mc 0,159	Pcs 1 Kg 30 mc 0,159
CAGE - C	CAGE - C

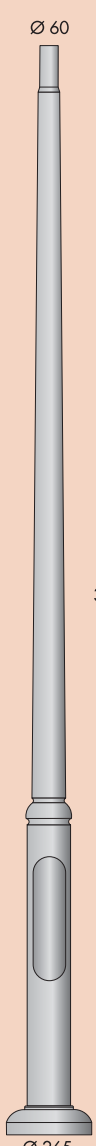
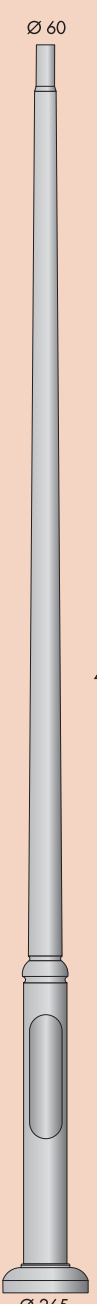
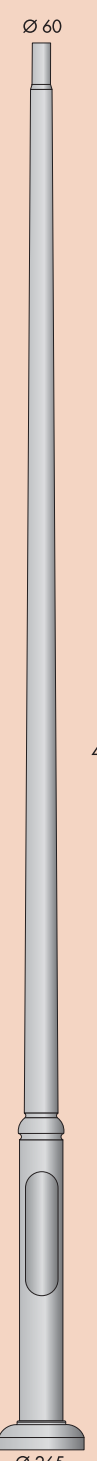
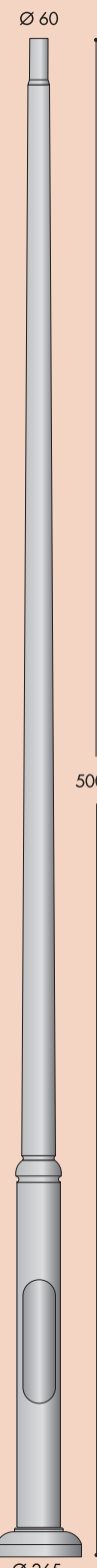
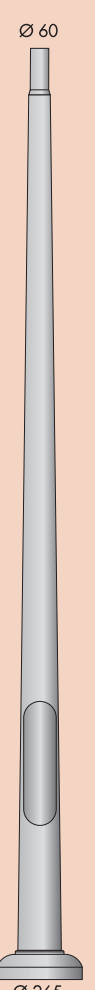
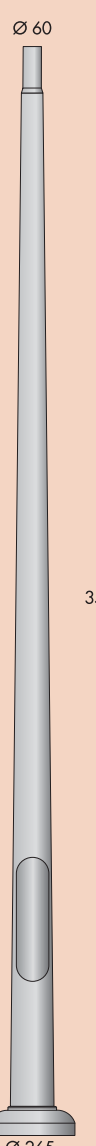
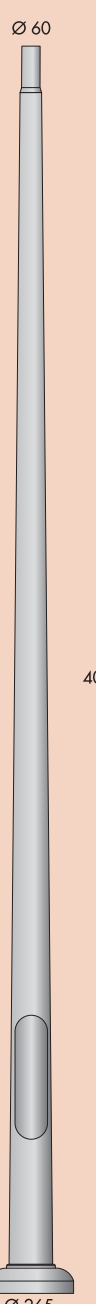
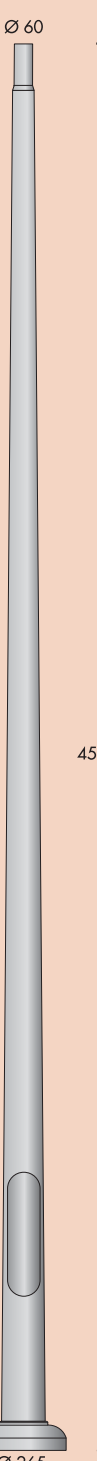
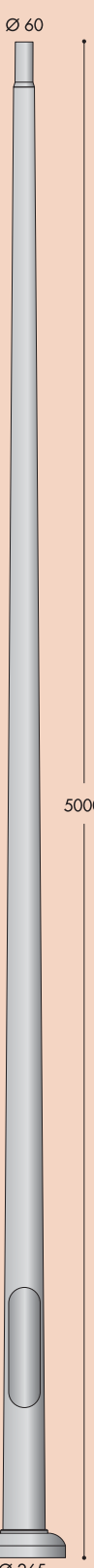
EKTOR 3500	EKTOR 4000	EKTOR 4500	EKTOR 5000	AKILLE 3000	AKILLE 3500	AKILLE 4000	AKILLE 4500	AKILLE 5000
000.367	000.371	000.374	000.377	000.414	000.417	000.421	000.424	000.427
000.368	000.372	000.375	000.378	000.415	000.418	000.422	000.425	000.428
000.369	000.373	000.376	000.379	000.416	000.419	000.423	000.426	000.429
DOOR IS OPTIONAL				DOOR IS OPTIONAL				
								
Ø 265	Ø 265	Ø 265	Ø 265	Ø 265	Ø 265	Ø 265	Ø 265	Ø 265
3500	4000	4500	5000	3000	3500	4000	4500	5000
Ø 60	Ø 60	Ø 60	Ø 60	Ø 60	Ø 60	Ø 60	Ø 60	Ø 60
Pcs 1 Kg 33 mc 0,185	Pcs 1 Kg 36 mc 0,212	Pcs 1 Kg 39 mc 0,238	Pcs 1 Kg 42 mc 0,265	Pcs 1 Kg 30 mc 0,159	Pcs 1 Kg 33 mc 0,185	Pcs 1 Kg 36 mc 0,212	Pcs 1 Kg 39 mc 0,238	Pcs 1 Kg 42 mc 0,265
CAGE - C	CAGE - D	CAGE - D	CAGE - D	CAGE - C	CAGE - C	CAGE - D	CAGE - D	CAGE - D